



# **HM682 Digital Mobile Radio**

## **User Manual**

# Preface

Welcome to the world of Hytera US Inc and thank you for purchasing this product. This manual includes a description of the functions and step-by-step procedures for use.

To avoid bodily injury or property loss caused by incorrect operation, please carefully read the *Safety Information Booklet* before use.

This manual is applicable to the following product:

[HM682 Digital Mobile Radio](#)

## Copyright Information

Hytera is the trademark or registered trademark of Hytera Communications Corporation Limited (the Company). The Company retains the ownership of its trademarks and product names. All other trademarks and/or product names that may be used in this manual are properties of their respective owners.

The purchase of this product shall not be deemed to grant, either directly or by implication, any rights to the purchaser regarding the Company's computer programs. The Company's computer programs may not be copied, modified, distributed, decompiled, or reverse-engineered in any manner without the prior written consent of the Company.

## Disclaimer

The Company endeavors to achieve the accuracy and completeness of this manual, but no warranty of accuracy or reliability is given. All the specifications and designs are subject to change without notice due to continuous technological development. No part of this manual may be copied, modified, translated, or distributed in any manner without the prior written consent of the Company.

We do not guarantee, for any particular purpose, the accuracy, validity, timeliness, legitimacy or completeness of the third-party products and contents involved in this manual.

If you have any suggestions or would like to receive more information, please visit our website at: <https://www.hytera.us>.

# Contents

<b>Documentation Information</b> .....	<b>3</b>
<b>1. Packing List</b> .....	<b>5</b>
<b>2. Product Overview</b> .....	<b>6</b>
2.1 Product Layout .....	6
2.2 Programmable Keys .....	7
<b>3. Installation</b> .....	<b>8</b>
3.1 Precautions .....	8
3.2 Tools .....	8
3.3 Parts .....	9
3.4 Procedure .....	10
<b>4. Basic Operations</b> .....	<b>11</b>
4.1 Turn On or Off the Radio .....	11
4.2 Adjust Volume .....	11
4.3 Select a Zone .....	11
4.4 Select a Channel .....	11
<b>5. Status Indications</b> .....	<b>12</b>
5.1 LCD Icons .....	12
5.2 LED Indicators .....	13
<b>6. Call Services</b> .....	<b>14</b>
6.1 Group Call .....	14
6.1.1 Initiate a Group Call .....	14
6.1.2 Answer a Group Call .....	14
6.1.3 End a Group Call .....	14
6.2 Private Call .....	14
6.2.1 Initiate a Private Call .....	14
6.2.2 Receive a Private Call .....	15
6.2.3 End a Private Call .....	15
6.3 All Call .....	15
6.3.1 Initiate an All Call .....	15
6.3.2 Receive an All Call .....	16
6.3.3 End an All Call .....	16
6.4 Analog Call .....	16
<b>7. Message Services</b> .....	<b>17</b>
7.1 View a Message .....	17
7.2 Delete a Message .....	17
<b>8. Contacts</b> .....	<b>18</b>
<b>9. Settings</b> .....	<b>19</b>

9.1 Basic Settings .....	19
9.1.1 Set Display .....	19
9.1.2 Set USB Path .....	19
9.1.3 Set Language .....	20
9.1.4 Enable LED Indicator .....	20
9.1.5 Reset a Radio .....	20
9.2 Call Settings .....	20
9.2.1 Set Power Level .....	20
9.2.2 Set Talking Alias .....	20
9.2.3 Enable Dual Slot Data .....	21
9.2.4 Enable Talk Around .....	21
9.2.5 Set Squelch Level .....	21
9.2.6 Enable Compandor .....	21
9.3 Security Settings .....	21
9.3.1 Encryption .....	21
9.3.2 Lone Worker .....	22
9.3.3 Enable Scrambler .....	22
9.3.4 Enable Horn & Lights .....	22
9.3.5 Kill and Revive the Radio .....	23
9.4 Audio .....	23
9.4.1 Enable Mic AGC .....	23
9.4.2 Enable AI-based Noise Cancellation .....	23
9.4.3 Set Audio Mode .....	24
9.4.4 Set MIC & SPK .....	24
<b>10. Profiles .....</b>	<b>26</b>
10.1 Switch Profiles .....	26
10.2 Set Alert Tone .....	26
<b>11. Radio Features .....</b>	<b>27</b>
11.1 Scan .....	27
11.1.1 Enable Scan .....	27
11.1.2 Set Scan List .....	27
11.2 Positioning .....	27
11.2.1 Enable Positioning .....	28
11.2.2 View Position .....	28
11.2.3 Enable Call Location .....	28
11.2.4 Enable GPS Report .....	29
11.3 BT .....	29
11.3.1 Connect to a BT Device .....	29
11.3.2 Switch BT Audio .....	30
11.3.3 Set BT .....	30





11.3.4 Enable BT Location .....	30
11.4 One Touch Call/Menu.....	30
11.5 Roam .....	31
11.6 Clarity Transmission .....	31
11.7 Ignition Sense .....	31
11.8 Public Address.....	32
11.9 Priority Interrupt.....	32
11.10 XPT .....	33
<b>12. Emergency Service .....</b>	<b>34</b>
12.1 Initiate an Emergency Call.....	34
12.2 Receive an Emergency Call .....	35
12.3 End an Emergency Call.....	35
12.4 Emergency Erase Data .....	35
<b>13. Troubleshooting .....</b>	<b>36</b>
<b>14. Care and Cleaning.....</b>	<b>31</b>
14.1 Product Care.....	31
14.2 Product Cleaning .....	31
<b>15. Optional Accessories.....</b>	<b>32</b>
<b>16. Abbreviations.....</b>	<b>34</b>

# Documentation Information

This section describes the conventions and revision history of this document.

## Documentation Conventions

### Instruction Conventions

Icon	Description
 <b>TIP</b>	Indicates information that can help you make better use of your product.
 <b>NOTE</b>	Indicates references that can further describe the related topics.
 <b>CAUTION</b>	Indicates situations that could cause data loss or equipment damage.
 <b>WARNING</b>	Indicates situations that could cause minor personal injury.
 <b>DANGER</b>	Indicates situations that could cause major personal injury or even death.

### Notation Conventions

Item	Description	Example
<b>Boldface</b>	Denotes menus, tabs, parameter names, window names, dialogue names, and hardware buttons.	To save the configuration, click <b>Apply</b> .
		The <b>Log Level Settings</b> dialogue box appears.
		Press the <b>PTT</b> key.
" "	Denotes messages, directories, file names, folder names, and parameter values.	The screen displays "Invalid Battery!".
		Open "PSS.exe".
		Go to "D:/opt/local".
		In the Port text box, enter "22".
>	Directs you to access a multi-level menu.	Go to <b>File &gt; New</b> .
<i>Italic</i>	Denotes document titles.	For details about using the DWS, refer to <i>Dispatch Workstation User Guide</i> .
Courier New	Denotes commands and their execution results.	To set the IP address, run the following command:  vos-cmd - m name IP

## Revision History

Document Version	Release Date	Description
00	September 2022	Initial release.



# 1. Packing List

Unpack carefully and check that you have received the following items. If any item is missing or damaged, contact your dealer.

Item	Quantity (PCS)	Item	Quantity (PCS)
Radio	1	Power Cord (with fuse)	1
Mounting Bracket	1	Self-tapping Screw (4.8 mm x 20 mm)	4
Locking Knob	2	Self-tapping Screw (4 mm x 16 mm)	3
Palm Microphone	1	Documentation Kit	1
Microphone Hanger	1	/	/

---

## NOTE

- Figures in this manual are only for reference.
  - Check and ensure that the frequency band marked on the antenna label matches that on the radio label. If not, contact your dealer.
-

## 2. Product Overview

### 2.1 Product Layout

#### Front Panel

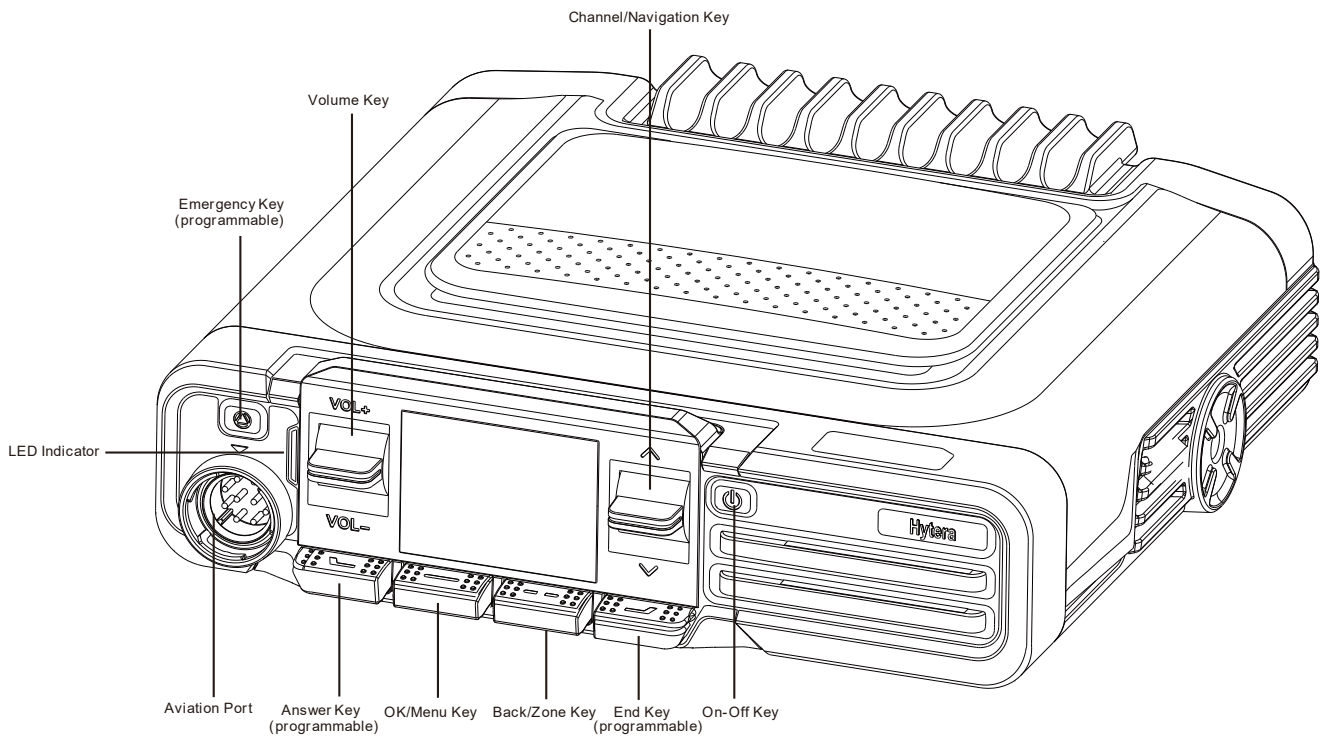

#### Rear Panel

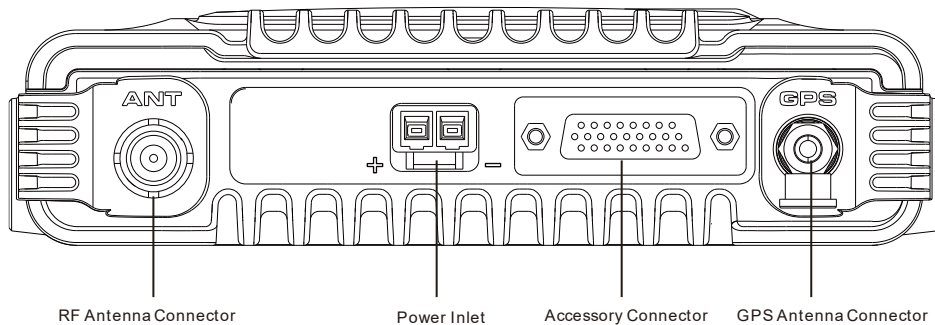

---

#### NOTE

The GPS antenna connector is only used to install the GNSS antenna on radios with the Location feature.

---

## Palm Microphone

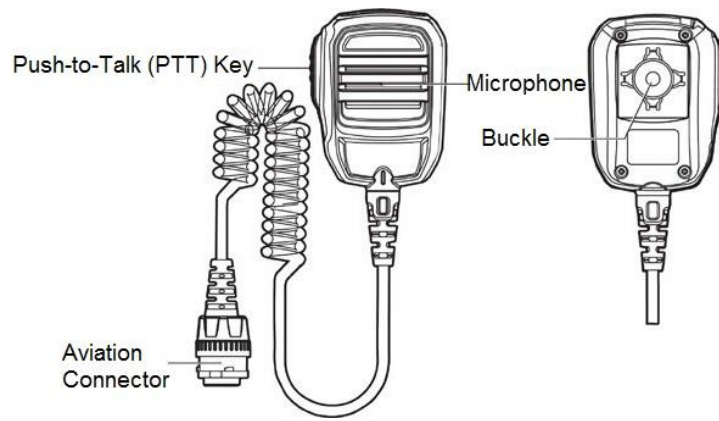

## 2.2 Programmable Keys

You can request your dealer to program the **Emergency** key, **Answer** key, and **End** key as shortcuts to assignable radio features.

## 3. Installation

### 3.1 Precautions

Before installation, read the following guidelines carefully:

- Before installation, ensure that the vehicle power supply has a negative ground with the voltage of  $13.6\pm 15\%$  V.
- Before installation, measure the length of screws protruding from the radio surface. During installation, drill the holes on the vehicle according to the screw length to avoid damaging the vehicle wires or other components.
- Use the antenna and power cord approved by the Company.
- Use the mounting bracket approved by the Company. Otherwise, the accidental drop of the radio may injure people in the vehicle.
- Install the radio at a position where you can easily reach the front panel.
- To facilitate wiring, keep sufficient space at the back of the radio.
- When replacing the fuse for the DC power cord, ensure the new fuse shares the same specification with the old one.
- If any other communication devices such as repeaters are in the vicinity of the radio, keep the antenna of these devices at least 10 meters away from that of the radio.

### 3.2 Tools

- electric drill
- Phillips screwdriver
- T20 torx screwdriver

### 3.3 Parts

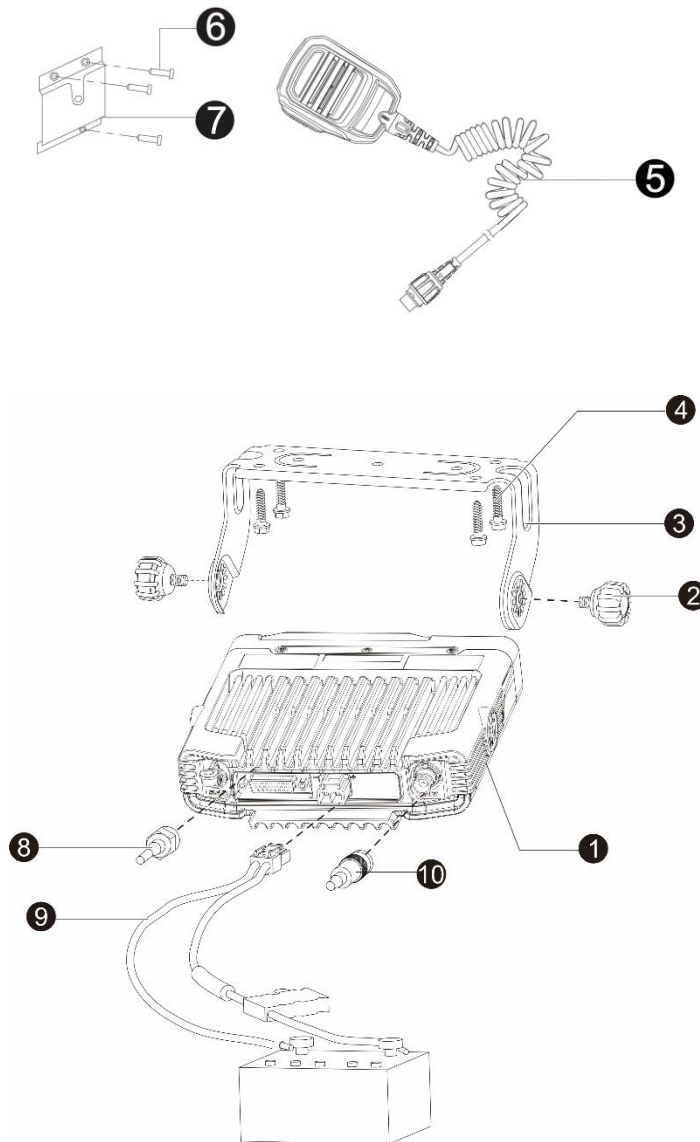

No.	Part Name	No.	Part Name
1	Radio	6	Self-tapping Screw (4 mm x 16 mm)
2	Locking Knobs	7	Microphone Hanger
3	Mounting Bracket	8	GNSS Antenna
4	Self-tapping Screw (4.8 mm x 20 mm)	9	Power Cord (with fuse)
5	Palm Microphone	10	RF Antenna

---

 **NOTE**

- The RF antenna is optional.
  - The GNSS antenna is a standard accessory for radios with the Location feature.
- 

## 3.4 Procedure

1. Install the radio.
  - a. Select a location on the vehicle.
  - b. Hold the mounting bracket to the location, and then mark the mounting holes.
  - c. Drill holes at the mounting holes.
  - d. Use the screws (4.8 mm x 20 mm) to secure the mounting bracket.
  - e. Connect the RF antenna, GNSS antenna, and power cord to the radio.
  - f. Slide the radio into the mounting bracket, and then fasten the locking knobs.
2. Install the palm microphone.
  - a. Select a location on the vehicle where you can reach the palm microphone easily.
  - b. Hold the microphone hanger to the location, and then mark the mounting holes.
  - c. Drill holes at the mounting holes.
  - d. Use the screws (4 mm x 16 mm) to secure the microphone hanger.
  - e. Align the triangle index on the palm microphone with that on the radio.
  - f. Plug the aviation connector to the palm microphone into the aviation port on the radio, and then rotate the connector clockwise to secure it.
  - g. Place the palm microphone on the hanger.

## 4. Basic Operations

### 4.1 Turn On or Off the Radio

- To turn on the radio, connect the radio to power supply or long press the **On-Off** key.
- To turn off the radio, long press the **On-Off** key.

### 4.2 Adjust Volume

Toggle the **Volume** key up to increase the volume or down to decrease the volume.

### 4.3 Select a Zone

- On the home screen, press the **Back/Zone** key, toggle the **Channel/Navigation** key to select a zone, and then press the **OK/Menu** key.
- Press the preprogrammed **Zone Up** key or **Zone Down** key.





















### 4.4 Select a Channel

You can toggle or press keys to switch to a channel within the same zone by default. If the Cross-Zone Switchover feature is enabled, you can switch to a channel in other zones.









- Method 1  
On the home screen, toggle the **Channel/Navigation** key.
- Method 2
  - a. On the home screen, press the **Back/Zone** key.
  - b. Toggle the **Channel/Navigation** key to select a zone.
  - c. Press the **OK/Menu** key.
  - d. Toggle the **Channel/Navigation** key to select a channel.
  - e. Press the **OK/Menu** key.
- Method 3  
Press the preprogrammed **Channel Up** key or **Channel Down** key.
- Method 4  
Press the preprogrammed **Preset Channel** key.

# 5. Status Indications

## 5.1 LCD Icons

Icon	Radio Status
	The radio detects no signal.
	More bars indicate stronger signal.
	The radio works in low power mode.
	The radio works in high power mode.
	An accessory is connected.
	The GPS feature is enabled, and valid positioning data has been received.
	The GPS feature is enabled, but no valid positioning data has been received.
	The BT feature is enabled.
	A BT device is connected.
	The Mode Automatic Switch feature is enabled.
	The radio is in emergency mode.
	The radio stays on a site.
	The radio is roaming.
	The Scrambler or Encrypt feature is enabled.
	The Over the Air Encrypt feature is enabled.
	The radio is scanning.
	The radio stays on an active channel.
	The radio stays on Priority Channel 1.
	The radio stays on Priority Channel 2.
	The radio has switched to the mixed channel.
	The Monitor feature is enabled.



Icon	Radio Status
	The speaker is on.
	The radio works in silent mode.
	The radio works in profile 1.
	The radio works in profile 2.
	The radio works in profile 3.
	There is/are (a) new message(s).
	The inbox is full.
	There is/are (a) missed call(s).

## 5.2 LED Indicators

LED Indicator	Radio Status	
Flashes green	The radio is being turned on.	
Glowes green	The radio is receiving.	
Glowes red	The radio is transmitting.	
Flashes orange slowly	The radio is scanning or roaming.	
Flashes orange rapidly	The radio is in Emergency mode.	
Glowes orange	Call hang time: No voice is being transmitted or received during a call. Within such a period, you can press and hold the <b>PTT</b> key and speak.	
Flashes blue	Every 3s	The BT feature is enabled, but the radio is not connected to any BT device.
	Every 1.5s	A BT device is connected.
	Every 0.1s	The BT feature is being disabled.

## 6. Call Services

To ensure optimal voice quality on the receiving radio, keep the microphone 2.5 cm to 5 cm away from your mouth during speaking.

### 6.1 Group Call

A group call is a call from an individual user to other group members.

#### 6.1.1 Initiate a Group Call Through Preset Contact

1. On the home screen, toggle the **Channel/Navigation** key to select a digital channel.
2. Press and hold the **PTT** key.

#### Through Contact List

1. Enter the **Contact** interface.
  - Press the preprogrammed **Contact List** or **Favorite Contact List** key.
  - On the home screen, go to **Menu > Contact**.
2. Select a group contact.
3. Press and hold the **PTT** key.

#### Through One Touch Call/Menu

Press the preprogrammed **One Touch Call/Menu** key, and then press and hold the **PTT** key.

### 6.1.2 Answer a Group Call

You can answer a group call without any operation.

### 6.1.3 End a Group Call

A group call ends when the call hang time expires.

## 6.2 Private Call

A private call is a call from an individual user to another individual user.

### 6.2.1 Initiate a Private Call Through Preset Contact

1. On the home screen, toggle the **Channel/Navigation** key to select a digital channel.
2. Press and hold the **PTT** key.

## Through Contact List

1. Enter the **Contact** interface.
  - Press the preprogrammed **Contact List** or **Favorite Contact List** key.
  - On the home screen, go to **Menu > Contact**.
2. Select a private contact.
3. Press and hold the **PTT** key.

## Through Call Logs

1. On the home screen, go to **Menu > Call Logs**.
2. Select a private call record.
3. Press and hold the **PTT** key.

## Through One Touch Call/Menu

Press the preprogrammed **One Touch Call/Menu** key, and then press and hold the **PTT** key.

## 6.2.2 Receive a Private Call

You can answer a private call without any operation.

## 6.2.3 End a Private Call

A private call ends when the call hang time expires.

## 6.3 All Call

An all call is a call from an individual user to all the other users on the current digital channel.

---

### NOTE

Contact your dealer to pre-configure the All Call feature.

---

### 6.3.1 Initiate an All Call

#### Through Preset Contact

1. On the home screen, toggle the **Channel/Navigation** key to select a preset all call contact on the digital channel.
2. Press and hold the **PTT** key.

#### Through Contact List

1. Enter the **Contact** interface.
  - Press the preprogrammed **Contact List** or **Favorite Contact List** key.
  - On the home screen, go to **Menu > Contact**.

2. Select an all call contact.
3. Press and hold the **PTT** key.

## Through One Touch Call/Menu

Press the preprogrammed **One Touch Call/Menu** key, and then press and hold the **PTT** key.

### 6.3.2 Receive an All Call

You can answer an all call without any operation.

### 6.3.3 End an All Call

An all call ends when the caller releases the **PTT** key.

## 6.4 Analog Call

An analog call is a call on the analog channel.

### Call without Signaling

On an analog channel without signaling, you can initiate a call to all the other users on the channel.

1. On the home screen, toggle the **Channel/Navigation** key to select an analog channel.
2. Press and hold the **PTT** key.

### Call with Signaling

On an analog channel with signaling, you can initiate a call to a specific contact on the channel.

---

#### **NOTE**

- Contact your dealer to pre-configure the signalings.
- HDC1200 (compatible with MDC1200) and two-tone signalings are available.
- The method to make a call with signaling is the same, regardless of signaling types.

- 
1. On the home screen, go to **Menu > Contact**, or press the preprogrammed **Contact List** or **Favorite Contact List** key.
  2. Select a contact.
  3. Press and hold the **PTT** key or the preprogrammed **One Touch Call/Menu** key.

# 7. Message Services

Message allows you to send and receive text messages.

## 7.1 View a Message

- Upon message reception, press the **OK/Menu** key.
- On the home screen, go to **Menu > Message**, select a message, and then press the **OK/Menu** key.

## 7.2 Delete a Message

1. On the home screen, go to **Menu > Message**.
2. Select a conversation.
3. Press the **OK/Menu** key.
4. Toggle the **Channel/Navigation** key to select a message.
5. Press the **OK/Menu** key, and then do either of the following:
  - To delete the selected message, select **Delete**.
  - To delete the conversation, select **Delete All**.

## 8. Contacts

To view the contact information, do the following:

1. On the home screen, go to **Menu > Contact** or press the preprogrammed **Contact List** key.
2. Select a contact.

# 9. Settings

You can set radio parameters including **Basic Settings**, **Call Settings**, and **Security Settings**.

## 9.1 Basic Settings

### 9.1.1 Set Display

On the home screen, go to **Menu > Settings > Basic Settings > Display**, and then set any of the following:

- Backlight

The backlight illuminates the display and keypad.

- In the **Display** interface, select **Backlight**.
- Toggle the **Channel/Navigation** key to select **Off**, **On**, or **Timed**.
- Press the **OK/Menu** key.

- Night mode

The display supports both day mode and night mode. The screen brightness and user interface vary with the display mode.

- In the **Display** interface, select **Night Mode**.
- Press the **OK/Menu** key to switch between the two modes.

- Brightness

Small level number represents high screen brightness.

- In the **Display** interface, select **Brightness**.
- Toggle the **Channel/Navigation** key to select a brightness level.
- Press the **OK/Menu** key.

### 9.1.2 Set USB Path

You can select a USB path for communication between the radio and external devices. For details, see the following table.

Option	Description	Operation
Rear Port First	When both the aviation port and accessory port are connected to external devices, the accessory connector can be used as the USB path.	<ul style="list-style-type: none"><li>● Through the menu<ol style="list-style-type: none"><li>On the home screen, go to <b>Menu &gt; Settings &gt; Basic Settings &gt; USB Path</b>.</li><li>Select the USB path option.</li></ol></li></ul>
Only Front Port	Only the aviation port can be used as the USB path.	

Option	Description	Operation
Only Rear Port	Only the accessory connector can be used as the USB path.	<ul style="list-style-type: none"> <li>● Press the preprogrammed <b>USB Path Switch</b> key.</li> </ul>

### 9.1.3 Set Language

1. On the home screen, go to **Menu > Settings > Basic Settings > Language**.
2. Toggle the **Channel/Navigation** key to select the display language.
3. Press the **OK/Menu** key.

### 9.1.4 Enable LED Indicator

1. On the home screen, go to **Menu > Profiles > Setting > LED**.
2. Press the **OK/Menu** key.

### 9.1.5 Reset a Radio

On the home screen, go to **Menu > Profiles > Setting > Restore initial value**.

## 9.2 Call Settings

### 9.2.1 Set Power Level

You can set the TX power level to high or low.

1. On the home screen, go to **Menu > Settings > Call Settings > Power Level**.
2. Select **High Power** or **Low Power**.
3. Press the **OK/Menu** key.

### 9.2.2 Set Talking Alias

On the home screen, go to **Menu > Settings > Call Settings > Talking Alias**, and then set either of the following:

- **Send Alias**

Send Alias allows you to send the radio alias during a call, so that the called party can identify the calling party by the alias.

  - a. In the **Talking Alias** interface, select **Send Alias**.
  - b. Press the **OK/Menu** key.
- **Auto Add Contacts**



If both the calling party and the called party enable the **Auto Add Contacts** and **Send Alias** features, the called party automatically adds the calling party to the contact list when receiving a call from the calling party.

- a. In the **Talking Alias** interface, select **Auto Add Contacts**.
- b. Press the **OK/Menu** key.

## 9.2.3 Enable Dual Slot Data

Dual Slot Data improves transmission rate when the radio transmits packet data with other devices through dual slots.

On the home screen, go to **Menu > Settings > Call Settings > Dual Slot Data**.

## 9.2.4 Enable Talk Around

You can communicate directly with terminals that are out of the communication coverage or when the repeater stops working.

On the home screen, go to **Menu > Settings > Call Settings > Talk Around**.

## 9.2.5 Set Squelch Level

The squelch level controls the signal reception threshold on analog channels. Higher squelch level requires stronger signal.

- On the home screen, go to **Menu > Settings > Call Settings > Squelch**, select **Open**, **Normal**, or **Tight**, and then press the **OK/Menu** key.
- Press the preprogrammed **Adjust Squelch Level** key to adjust the level.

## 9.2.6 Enable Compandor

Compandor allows the radio to compress the voice signal when transmitting and decompress the voice signal when receiving to improve the voice quality.

1. On the home screen, go to **Menu > Settings > Call Settings > Compandor**.
2. Press the **OK/Menu** key.

## 9.3 Security Settings

### 9.3.1 Encryption

#### 9.3.1.2 Enable Encryption

Encryption provides end-to-end voice and data encryption to protect your information security.

- On the home screen, go to **Menu > Settings > Security Settings > Encrypt > On/Off**, and then press the **OK/Menu** key.
- Press the preprogrammed **Scrambler/Encrypt** key.

---

 **NOTE**

When you enable Encryption, only the current channel is encrypted, and the channel remains to be encrypted after you switch the channel.

---

### 9.3.1.3 Select an Encryption Key

1. On the home screen, go to **Menu > Settings > Security Settings > Encrypt > Key List**.
2. Select an encrypt key.
3. Press the **OK/Menu** key twice.

### 9.3.2 Lone Worker

Lone Worker allows the radio to automatically send an emergency alarm to your companion or the control center, when you do not operate the radio or the radio does not transmit voice within the preset time. In this case, the radio enters the emergency mode.

- To enable Lone Worker, do either of the following:
  - On the home screen, go to **Menu > Settings > Security Settings > Lone Worker**, and then press the **OK/Menu** key.
  - Press the preprogrammed **Lone Worker** key.
- To exit the emergency mode, do any of the following:
  - Press the keys.
  - Rotate the knob.
  - Transmit voice.

### 9.3.3 Enable Scrambler

Scrambler allows the radio to invert audio signals at the sender's side and reverse the signals at the receiver so as to prevent eavesdropping.

- On the home screen, go to **Menu > Settings > Settings > Security Settings > Scrambler**.
- Press the preprogrammed **Scrambler/Encrypt** key.

### 9.3.4 Enable Horn & Lights

Horn & Lights allows the radio to set off alarms on external devices (for example, speaker or light), if you do not operate the radio within the preset time after the radio receives an emergency alarm, call notification, or a private call.

You can request your dealer to configure one of the following types of Horn & Lights for your radio.

Alarm Type	Description
Alarm Re-Arm	The Horn & Lights feature is enabled or disabled based on the setting upon the last power-off.
Non-Permanent Manual Re-Arm	The Horn & Lights feature must be enabled every time upon power-on.
Permanent External Alarm	The Horn & Lights feature is enabled whenever the radio is powered on.

- On the home screen, go to **Menu > Accessories > Horn & Lights**, and then press the **OK/Menu** key.
- Press the preprogrammed **Horn & Lights** key.

### 9.3.5 Kill and Revive the Radio

- To kill a radio, send a Kill command to a private contact to disable the radio.  
The killed radio can be monitored remotely, but is deprived of other features
- To revive a radio, reprogram the software, or send a Radio Enable command to the private contact.

## 9.4 Audio

### 9.4.1 Enable Mic AGC

Mic AGC allows the calling radio to control the voice output gain within a proper range during transmission, so as to provide improved voice with proper volume for the called radio. This feature ensures stable voice even in noisy environment.

With Mic AGC preprogrammed, do the following:

1. On the home screen, go to **Menu > Profiles > Setting > Audio Set**.
2. Select **Digital Mic AGC** or **Analog Mic AGC**.
3. Press the **OK/Menu** key.

### 9.4.2 Enable AI-based Noise Cancellation

Noise Cancellation allows the radio to automatically eliminate ambient noise when receiving or transmitting voice. This feature enhances the voice clarity, while also decreases the volume.

1. On the home screen, go to **Menu > Profiles > Setting > Audio Set > Noise Cancellation**.
2. Press the **OK/Menu** key.

### 9.4.3 Set Audio Mode

Audio Mode adds gain to audio signals at high, medium, and low frequency, thus optimize the audio quality.

1. On the home screen, go to **Menu > Profiles > Setting > Audio Set > Audio mode**.
2. Select an audio mode.
3. press the **OK/Menu** key.

### 9.4.4 Set MIC & SPK

MIC & SPK allows you to select the microphone and speaker to transmit and receive voice. With the audio accessory connected, you can switch the audio paths. For details, see the following tables.

#### MIC

Option	Description	Operation
Follow PTT	<ul style="list-style-type: none"> <li>● When you transmit voice through the <b>PTT</b> key on the radio, the radio uses the internal microphone.</li> <li>● When you transmit voice through the audio accessory, the radio uses the external microphone.</li> </ul>	<ul style="list-style-type: none"> <li>● Through the menu               <ol style="list-style-type: none"> <li>a. On the home screen, go to <b>Menu &gt; Settings &gt; Basic Settings &gt; MIC &amp; SPK</b>.</li> <li>b. Select <b>MIC Selection</b>.</li> <li>c. Select the audio option.</li> </ol> </li> <li>● Press the preprogrammed <b>Mic Set Switch</b> key to switch the audio path.</li> </ul>
Only Internal	The radio uses only the internal microphone.	
Only External	The radio uses only the microphone of the audio accessory, such as earpieces.	

#### SPK

Option	Description	Operation
External First	When audio accessories are connected, the radio uses the external speaker. Otherwise, the radio uses the internal speaker.	<ul style="list-style-type: none"> <li>● Through the menu               <ol style="list-style-type: none"> <li>a. On the home screen, go to <b>Menu &gt; Settings &gt; Basic Settings &gt; MIC &amp; SPK</b>.</li> <li>b. Select <b>SPK Selection</b>.</li> <li>c. Select the audio option.</li> </ol> </li> </ul>
Only Internal	The radio uses only the internal speaker.	

Option	Description	Operation
Only External	The radio uses only the speaker of the audio accessory, such as the remote speaker microphone.	<ul style="list-style-type: none"> <li>● Press the preprogrammed <b>SPK Set Switch</b> key.</li> </ul>

# 10. Profiles

## 10.1 Switch Profiles

Profiles allows you to set the audio and alert tone of the radio for clear voice in various scenarios. The radio supports the following two profiles:

- General: applicable to common scenarios.
- Customized profiles: applicable to scenarios other than those in General.

To switch profiles, do either of the following:

- On the home screen, go to **Menu > Profiles**, select a profile, and then press the **OK/Menu** key.
- Press the preprogrammed **Profiles Switch** key.

## 10.2 Set Alert Tone

- Turn On or Off Radio Tone

On the home screen, go to **Menu > Profiles > Setting > Tone > Radio Tone**.

- Turn On or Off Single Tone
  - a. Turn on Radio Tone.
  - b. In the **Tone** interface, select **Single Tone**.
  - c. Press the **OK/Menu** key.
  - d. Select a feature.
  - e. Press the **OK/Menu** key.
- Adjust the Volume of Radio Tone Volume
  - a. On the home screen, go to **Menu > Profiles > Setting > Tone > Radio Tone > Radio Tone Volume**.
  - b. Toggle the **Channel/Navigation** key to select a volume level.
- Adjust the Volume of Single Tone Volume
  - a. On the home screen, go to **Menu > Profiles > Setting > Tone > Single Tone**.
  - b. Select a feature.
  - c. Press the **OK/Menu** key.



# 11. Radio Features

## 11.1 Scan

### 11.1.1 Enable Scan

- On the home screen, go to **Menu > Scan > Scan On/Off**, and then press the **OK/Menu** key.
- Press the preprogrammed **Scan** key.

The radio scans according to the scan list preset for the current channel. During the scanning, the LCD displays , and the LED indicator flashes orange slowly.

When detecting activities on a channel, the radio stays on the channel and the LED indicator glows green. If the radio stays on Priority Channel 1 or Priority Channel 2, the LCD displays  or . If the radio stays on a non-priority channel, the LCD displays .

---

#### NOTE

If you do not want to hear activities on the channel, press the preprogrammed **Nuisance Temporary Delete** key to remove the channel from the scan list temporarily.

---

### 11.1.2 Set Scan List

The scan list is a list of up to 32 analog and digital channels that the radio scans.

On the home screen, go to **Menu > Scan**, select the scan list, and then do any of the following:

- To view or manage all channels on the current list, select **View Record**, and then press the **OK/Menu** key.
  - To set the list as the default scan list for the current channel, select **Set Default**, and then press the **OK/Menu** key.
  - To add a new channel to the list, select **Add CH**, and then press the **OK/Menu** key.
- 

#### NOTE

If you do not need to scan, you can delete all channels other than the current channel. If you want to preferentially hear the activities on a channel, you can select the channel, and then select **Set PrioCH-1** or **Set PrioCH-2**.

---

## 11.2 Positioning

Positioning allows you to collect the position information of the radio through satellites.

---

#### NOTE

This feature applies only to radios with GPS, BDS, or GLONASS.

---

## 11.2.1 Enable Positioning

1. On the home screen, go to **Menu > Position > Position On/Off**
2. Press the **OK/Menu** key.

## 11.2.2 View Position

### Local Position

1. On the home screen, go to the **Menu > Position > Position View**.
2. Press the **OK/Menu** key to view the position information of your radio (including longitude, latitude, speed, altitude, time, date, and the number of satellites).

### Contact Position

1. On the home screen, go to **Menu > Position > Query Location > Contact List**.
2. Select a contact.
3. Press the **OK/Menu** key to view the location information of a nearby private contact (including alias, direction, and distance).

## 11.2.3 Enable Call Location

During a call, if the transmitting radio is enabled with the Call Location feature, the receiving radio displays the location information of the transmitting radio when receiving valid positioning data.

### 11.2.3.2 Enable Voice with Location

Voice with Location allows the radio to report its location information when initiating a private call, a group call, or an emergency call.

1. On the home screen, go to **Menu > Position > Call Location > Voice with Location**.
2. Press the **OK/Menu** key.

### 11.2.3.3 Display Call Location

If the transmitting radio is enabled with the Voice w/Location feature and the receiving radio is enabled with the Display Call Location feature, the receiving radio displays the location information of the transmitting radio during a call.

1. On the home screen, go to **Menu > Position > Call Location > Display Call Location**.
2. Press the **OK/Menu** key.
3. Select **Display Type**.
4. Select **16 Azimuth & Dist.**, **Accur Azimuth & Dist.**, or **Talker Location**.
5. Press the **OK/Menu** key.



## 11.2.4 Enable GPS Report

GPS Report allows the radio to report its location information to the control center.

Press the preprogrammed **GPS Report** key, or you can consult your dealer to configure the GPS trigger, allowing the radio to automatically report the GPS data upon power-on/off, or according to the preset time or distance interval.

### Quick GPS

Based on GPS standard time, Quick GPS divides the GPS upload time into several equal-length time slices. These time slices are allocated to radios with different configurations for periodic upload and single upload. Each radio uses the same GPS upload time length to upload GPS data, improving upload efficiency and reliability.

If your dealer configures the feature to a digital channel, the channel only reports the quick GPS data.

## 11.3 BT

BT is a wireless technology that supports short-distance communications and data exchange between devices. You can connect the radio to a BT device through the built-in BT module.

---

### CAUTION

- To derive optimal communication quality, it is recommended to use the BT devices approved by the Company.
- If BT earpieces of other companies are used, you must use them with the wireless ring PTT of the Company. Otherwise, the earpieces cannot transmit.

- 
1. On the home screen, go to **Menu > BT**.
  2. Press the **OK/Menu** key.

After this feature is enabled, the LED indicator flashes blue every three seconds.

---

### NOTE

The BT feature applies only to radios with the BT module.

---

### 11.3.1 Connect to a BT Device

1. Turn on the BT device and enter the pairing status.

For details, refer to the accessory manual.

2. Search and connect to the BT device.
3. On the home screen, go to **Menu > BT > Auto Search**.
4. Select the BT device from the detected device list.

5. Press the **OK/Menu** key.

After the radio is connected to the BT device, the LED indicator of the radio flashes blue every 1.5 seconds.

### 11.3.2 Switch BT Audio

With the BT device connected, press the preprogrammed **BT Audio Switch** key to switch the audio output device between BT earpiece and the radio.

### 11.3.3 Set BT

- To view the BT name, on the home screen, go to **Menu > BT > My Device > BT Devices Name**.
- To enable visibility, on the home screen, go to **Menu > BT > My Device > Always Detected**, and then press the **OK/Menu** key.

Other BT devices can detect the radio.

- To view the BT information, on the home screen, go to **Menu > BT > My Device > Device Information**.

### 11.3.4 Enable BT Location

You can report the BT positioning information to the dispatcher after the radio detects BT beacon information. It is used for indoor positioning.

To enable BT Location, do the following:

1. On the home screen, go to **Menu > BT > BT Location**.
2. Press the **OK/Menu** key.

## 11.4 One Touch Call/Menu

One Touch Call/Menu allows you to initiate a preset service or switch to the function menu by pressing the preprogrammed **One Touch Call/Menu** key.

The following table shows the services that can be implemented by this feature and the corresponding operations.

Description	Operation
On an analog channel, you can initiate a call to a two-tone contact.	Press the preprogrammed <b>One Touch Call/Menu</b> key to initiate the service.
On a digital channel, you can do one of the following: <ul style="list-style-type: none"> <li>● Initiate a group, private, or all call.</li> <li>● Send a quick text message or position message to a private or group contact.</li> </ul>	

Description	Operation
<ul style="list-style-type: none"> <li>● Initiate an alert call, radio check, remote monitor, revive, or kill service.</li> <li>● Switch to a function menu or realize a function.</li> </ul>	<p><b>Call/Menu</b> key, and then press and hold the <b>PTT</b> key.</p>

## 11.5 Roam

Roam allows the radio to select base stations according to signal strength. This ensures seamless communication across sites or networks.

- To enable Roam, do either of the following:
  - Press the preprogrammed **Roam** key.
  - On the home screen, go to **Menu > Roaming > On/Off**, and then press the **OK/Menu** key.
- To set the roam list, do the following:
  - a. On the home screen, go to **Menu > Roaming > Roaming List**.
  - b. Select a roam list.
  - c. Do any of the following:
    - To view or manage all channels on the current list, select **View Record**, and then press the **OK/Menu** key.
    - To set the list as the default scan list for the current channel, select **Set Default**, and then press the **OK/Menu** key.
    - To add a new channel to the list, select **Add CH**, and then press the **OK/Menu** key.

## 11.6 Clarity Transmission

Clarity Transmission allows data to be transferred from one external device to another using the radio. The radio serves as the transparent transmission channel for data exchange between external devices without any additional adjustment. When the radio receives the data through the serial port, it transfers the data to a preset contact excluding an all call contact. If the radio fails to receive the data, it will exit Clarity Transmission.

With Clarity Transmission configured by your dealer, to enable Clarity Transmission, press the preprogrammed **Clarity Transmission Mode** key.

## 11.7 Ignition Sense

Ignition Sense controls the radio on or off and the **PTT** key enabled or disabled by starting or stopping your vehicle engine.

Four types of ignition sense are listed in the following table. The default type is **Disable Ignition Off**, and other types are enabled by your dealer.

Type	Description	Operation
Ignition or Switch	Allows you to turn the radio on or off by the engine or the <b>On-Off</b> key.	<ul style="list-style-type: none"> <li>● To turn the radio on, start the engine or long press the <b>On-Off</b> key.</li> <li>● To turn the radio off, stop the engine or press the <b>On-Off</b> key.</li> </ul>
Ignition Only	Allows you to turn the radio on or off by the engine.	<ul style="list-style-type: none"> <li>● To turn the radio on, start the engine.</li> <li>● To turn the radio off, stop the engine.</li> </ul>
PTT Disable	Allows you to enable the <b>PTT</b> key by the engine.	<ul style="list-style-type: none"> <li>● To enable the <b>PTT</b> key, start the engine.</li> <li>● To disable the <b>PTT</b> key, stop the engine.</li> </ul>
Disable Ignition Off	Allows you to turn the radio on by the engine or the <b>On-Off</b> key, and allows you to turn the radio off only by the <b>On-Off</b> key.	<ul style="list-style-type: none"> <li>● To turn the radio on, start the engine or long press the <b>On-Off</b> key.</li> <li>● To turn the radio off, press the <b>On-Off</b> key.</li> </ul>

## 11.8 Public Address

Public Address allows you to address public through the external speaker (connected to the accessory connector on the rear panel).

To enable Public Address, press the preprogrammed **Public Address** key.

## 11.9 Priority Interrupt

Priority Interrupt allows you to interrupt the ongoing activities (such as a call, a call hang status or remote monitor) on the current channel to release it: therefore, you can initiate a new call or a new data service on that channel. This feature includes manual priority interrupt and auto priority interrupt.

### Manual Priority Interrupt

Press the preprogrammed **Priority Interrupt** key to interrupt the ongoing activities.

### Auto Priority Interrupt

Auto Priority Interrupt includes Emergency Priority Interrupt, Call Back Priority Interrupt, Message Priority Interrupt, Radio Disable Priority Interrupt, and All Call Priority Interrupt.

You can interrupt an ongoing call by initiating an emergency call, all call, or sending a short message or the Radio Disable command.

---

 **NOTE**

Contact your dealer to pre-configure the Auto Priority Interrupt feature.

---

## 11.10 XPT

Extended Pseudo Trunk (XPT) system allows multiple repeaters to share logic channels and communicate through any of the repeaters in the site. In this way, XPT increases the communication efficiency and capacity of the conventional system.

- Single-site Trunking System: consists of a master repeater and multiple slave repeaters, which are connected to each other through IP switch.
- Multi-site Trunking System: connects multiple XPT single-site trunking systems through IP network.

---

 **NOTE**





Contact your dealer to pre-configure the XPT feature.

---

## 12. Emergency Service

Emergency Service allows you to seek help from your companion or the control center in case of emergency. You can initiate an emergency call with the highest priority even when your radio is transmitting or receiving.

In emergency mode, the radio transmits at high power level by default. According to the emergency type preset by your dealer, the radio gives different indications. The available emergency types are listed in the following table.

Emergency Type	Description
Siren Only	The radio emits siren and displays  and  , but does not transmit any emergency signal to the control center.
Regular	The radio gives visible or audible indications.
Silent	The radio gives no visible and audible indication.
Silent w/ Voice	The radio gives audible indication only upon receiving a call. Otherwise, the radio gives no audible or visible indication.
Alarm w/ Siren	The radio transmits the emergency signal to the control center, and then emits siren and displays  and  .

In addition, you can request your dealer to set one of the following emergency modes:

Emergency Mode	Description	Note
Call Only	It allows you to initiate an emergency call.	If the emergency type is Siren Only or Alarm w/Siren, you do not need to set the emergency mode.
Alarm w/Call	It allows you to send an emergency code and initiate an emergency call.	
Alarm	It allows you to send an emergency code.	

### 12.1 Initiate an Emergency Call

Press the preprogrammed **Emergency On** key to initiate an emergency call to the preset contact.

If the Alarm w/Call To Follow feature is configured by your dealer, you can speak into the microphone without pressing or holding the **PTT** key. If the preset voice cycles expire, you can press and hold the **PTT** key to initiate the emergency call again.

## 12.2 Receive an Emergency Call

You can answer an emergency call without any operation.

## 12.3 End an Emergency Call

- Calling party
  - Press the preprogrammed **Emergency Off** key.
  - Turn off the radio.
- Called party
  - Switch the channel.
  - Turn off the radio.

## 12.4 Emergency Erase Data

Emergency Erase Data allows the radio to erase encrypted data in case of emergency, so as to prevent unauthorized access.

When erasing the data, the radio stops voice and data services and returns to the home screen.

The encrypted data can be erased in the following cases:

- Press the **Answer** key and then the **PTT** key (within 1.5s) for two times, and then press the **Answer** key again.
- When the radio is killed, the data in the radio will be erased automatically.

# 13. Troubleshooting

Phenomena	Analysis	Solution
The radio cannot be turned on.	The power cord may be unconnected.	Connect the power cord properly .
The voice is unclear.	The signal may be weak.	Make sure that call participants are within the communication range.
The received voice is weak, discontinuous, or totally inactive.	The volume may be low.	Increase the volume, or contact your dealer to disable the Mic AGC feature.
	The antenna may be loosened or installed improperly.	Turn the radio off, and then reattach the antenna.
	The speaker may be blocked or damaged.	Clean the surface of the speaker.
Communications with group members are unavailable.	The frequency or signaling type may be inconsistent with that of other members.	Set your TX/RX frequency and signaling to the same as that of other members.
	The channel type (digital or analog) may be set inconsistently.	Make sure that all members are on the same digital or analog channel.
	You may be too far away from the group members.	Move towards other members.
	The signal may be weak.	Make sure that call participants are within the communication range.
There are unknown voices or noises on the channel.	You may be interrupted by radios using the same frequency.	Change the frequency, or adjust the squelch level.
	The radio may be set with no signaling.	Set signaling for all member radios to avoid interference at the same frequency.
There is too much noise and hiss.	The signal may be weak.	Make sure that call participants are within the communication range.



Phenomena	Analysis	Solution
	The radio may be in an unfavorable position. For example, the signal may be blocked by tall buildings or frustrated in the underground areas.	Move to an open and flat area, and then restart the radio.
	The radio may suffer from external disturbance (such as electromagnetic interference).	Stay away from the equipment that may cause interference.
The keys are unavailable.	The keypad may not work temporarily.	Restart the radio.
The LCD does not display any information.	The LCD may not work temporarily.	Restart the radio.
The GPS cannot locate your position.	The GPS module may be connected improperly.	Reconnect the GPS module.
	The radio may be at an unfavorable position, so no GPS signal is received.	Move to an open and flat area, and try again.

If the above solutions cannot solve your problems, or you may have some other queries, please contact us or your local dealer for more technical support.

# 14. Care and Cleaning

To guarantee optimum performance as well as a long service life of the product, please follow the tips below.

## 14.1 Product Care

- Do not pierce or scrape the product.
- Keep the product away from substances that can corrode the circuitry.
- Close the accessory connector cover when no accessory is in use.

## 14.2 Product Cleaning

---

### CAUTION

Turn off the product and remove the battery before cleaning.

---

- Clean up the dust and fine particles on the product surface and charging piece with a clean and dry lint-free cloth or a brush regularly.
- Use neutral cleanser and non-woven fabric to clean the keys, knobs, and front case after long-time use. Do not use chemical preparations such as stain removers, alcohol, sprays or oil preparations, so as to avoid surface case damage.
- Make sure the product is completely dry before use.

# 15. Optional Accessories

---

## CAUTION

Use the accessories approved by the Company only. Otherwise, we will not be liable for any loss or damage arising out of the use of unauthorized accessories.

---

Contact your local dealer for the optional accessories used with the product.

## 16. Abbreviations

Abbreviation	Full Name
A	
AGC	Automatic Gain Control
G	
GPS	Global Positioning System
L	
LCD	Liquid-Crystal Display
LED	Light-Emitting Diode
P	
PTT	Push-To-Talk
X	
XPT	Extended Pseudo Trunk



© 2023 Hytera US Inc. All Rights Reserved.

8 Whatney, Irvine, CA 92840

[support@hytera.us](mailto:support@hytera.us)

<https://www.hytera.us>