



HM652 Digital Mobile Radio

User Manual

Preface

Welcome to the world of Hytera and thank you for purchasing this product. This manual includes a description of the functions and step-by-step procedures for use.

To avoid bodily injury or property loss caused by incorrect operation, please carefully read the *Safety Information Booklet* before use.

This manual is applicable to the following product: [HM652 Digital Mobile Radio](#)

Copyright Information

Hytera is the trademark or registered trademark of Hytera Communications Corporation Limited and retains the ownership of its trademarks and product names. All other trademarks and/or product names that may be used in this manual are properties of their respective owners.

The product described in this manual may include the Company's computer programs stored in memory or other media. Laws in the US and other countries or areas protect the exclusive rights of the Company with respect to its computer programs. The purchase of this product shall not be deemed to grant, either directly or by implication, any rights to the purchaser regarding the Company's computer programs. The Company's computer programs may not be copied, modified, distributed, decompiled, or reverse-engineered in any manner without the prior written consent of the Company.

Disclaimer

The Company endeavors to achieve the accuracy and completeness of this manual, but no warranty of accuracy or reliability is given. All the specifications and designs are subject to change without notice due to continuous technological development. No part of this manual may be copied, modified, translated, or distributed in any manner without the prior written consent of the Company.

We do not guarantee, for any particular purpose, the accuracy, validity, timeliness, legitimacy or completeness of the third-party products and contents involved in this manual.

If you have any suggestions or would like to receive more information, please visit our website at: <https://www.hytera.us>.



Contents

Documentation Conventions	1
1. Packing List	2
2. Product Layout	3
3. Installation	4
3.1 Precautions	4
3.2 Tools	4
3.3 Parts	5
3.4 Procedure	6
4. Basic Operations	7
4.1 Turn On or Off the HM652	7
4.2 Adjust the Volume	7
4.3 Switch Between Day and Night Modes	7
4.4 Set the Backlight to Always On	7
4.5 Lock or Unlock the Key	7
4.6 Select the Zone	8
4.7 Select the Channel	8
5. Status Indications	9
5.1 LCD Icons	9
5.2 LED Indicator	10
6. Call Services	11
6.1 Calls on Digital Channel	11
6.1.1 Make a Call	11
6.1.2 Answer a Call	11
6.1.3 End a Call	11
6.2 Calls on Analog Channels	12
6.2.1 Make a Call Without Signaling	12
6.2.2 Make a Call with Signaling	12
7. Basic Settings	13
7.1 Power Level	13
7.2 Audio	13
7.2.1 Microphone and Speaker	13
7.2.2 Mic AGC	14
7.2.3 AI-based Noise Cancellation	14
7.3 USB Path	14
7.4 Location	14
7.4.1 Voice with Location	15
7.4.2 GPS Report	15

7.4.3 Quick GPS.....	15
7.5 BT	15
7.5.1 Enable BT.....	16
7.5.2 Connect to a BT Device	16
7.5.3 Switch the Audio Output Path	16
8. Safety and Security.....	17
8.1 Horn & Lights.....	17
8.2 Emergency	17
8.2.1 Make an Emergency Call.....	18
8.2.2 Answer an Emergency Call.....	18
8.2.3 End an Emergency Call	18
8.3 Lone Worker	18
8.4 Encryption.....	19
8.5 Emergency Erase Data	19
8.6 Radio Disable and Radio Enable	19
9. Advanced PMR Features.....	20
9.1 One Touch Call.....	20
9.2 Scan.....	20
9.3 Roam	20
9.4 Talk Around	20
9.5 Squelch Level	21
9.6 Clarity Transmission	21
9.7 Priority Interrupt	21
9.8 Ignition Sense.....	21
9.9 Public Address.....	22
9.10 XPT.....	22
10. Troubleshooting.....	23
11. Care and Cleaning.....	25
11.1 Product Care	25
11.2 Product Cleaning.....	25
12. Optional Accessories	26
13. Abbreviations	27

Documentation Conventions

Icon Conventions

Icon	Description
 NOTE	Indicates references that can further describe the related topics.
 CAUTION	Indicates situations that could cause data loss or equipment damage.
 DANGER	Indicates situations that could cause major personal injury or even death.

Notation Conventions

Item	Description	Example
Boldface	Denotes menus, tabs, parameter names, window names, dialogue names, and hardware buttons.	To save the configuration, click Apply .
		The Log Level Settings dialogue box appears.
		Press the PTT key.
" "	Denotes messages, directories, file names, folder names, and parameter values.	The screen displays "Invalid Battery!".
		Open "PSS.exe".
		Go to "D:/opt/local".
>	Directs you to access a multi-level menu.	In the Port text box, enter "22".
		Go to File > New .
		For details about using the DWS, refer to <i>Dispatch Workstation User Guide</i> .
<i>Italic</i>	Denotes document titles.	To set the IP address, run the following command: vos-cmd - m name IP
Courier New	Denotes commands and their execution results.	

1. Packing List

Unpack carefully and check that you have received the following items. If any item is missing or damaged, contact your dealer.

Item	Quantity (PCS)	Item	Quantity (PCS)
HM652	1	Power Cord (with fuse)	1
Mounting Bracket	1	Self-tapping Screw (4.8 mm x 20 mm)	4
Locking Knobs	2	Self-tapping Screw (4 mm x 16 mm)	3
Palm Microphone	1	Documentation Kit	1
Microphone Hanger	1	/	/

NOTE

- Figures in this manual are only for reference.
- Check whether the frequency band marked on the antenna label matches that on the HM652 label. If not, contact your dealer.

2. Product Layout

HM652

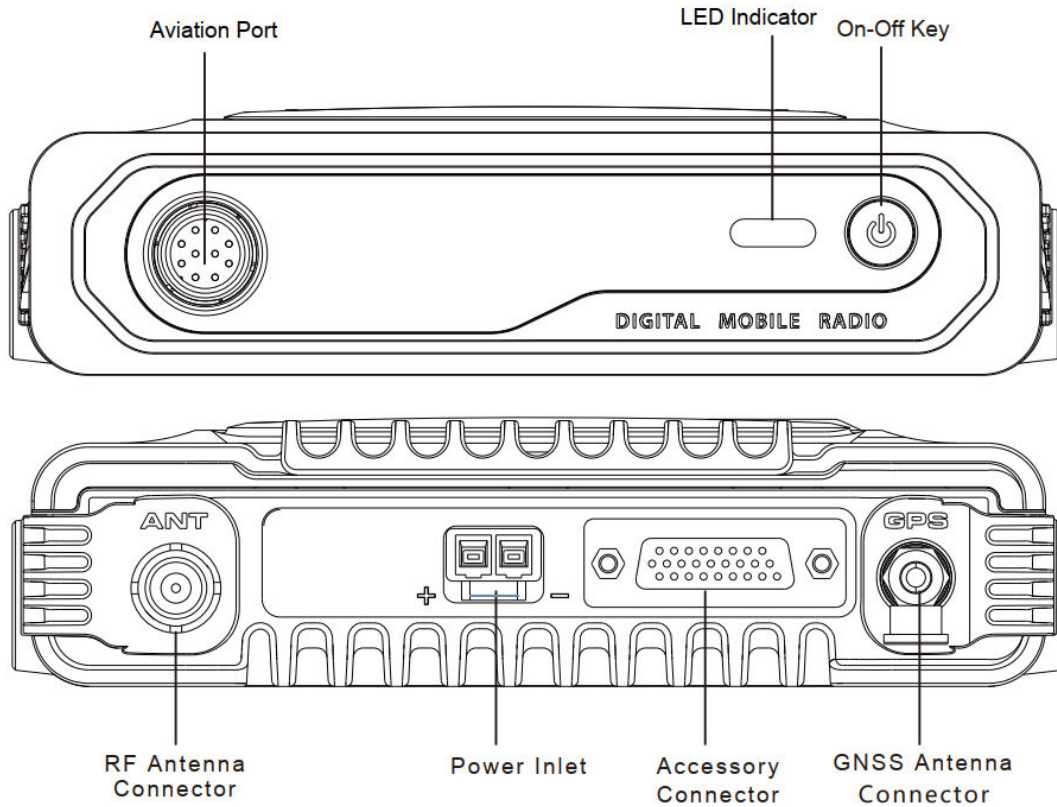

NOTE

The GNSS antenna is available only for the HM652 with the Location feature.

Palm Microphone

You can request your dealer to program the **Top Key (TK)**, **P1** key, and **P2** key as shortcuts to assignable features.

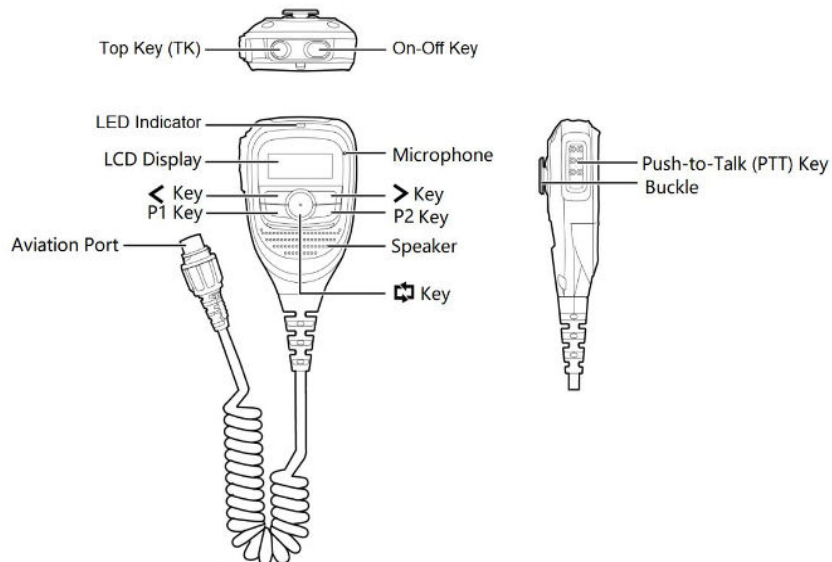

3. Installation

3.1 Precautions

Before installation, read the following guidelines carefully:

- Before installation, ensure that the vehicle power supply has a negative ground with the voltage of $13.6\pm 15\%$ V.
- Before installation, measure the length of screws protruding from the HM652 surface. During installation, drill the holes on the vehicle according to the screw length to avoid damaging the vehicle wires or other components.
- Use the antenna and power cord approved by the Company.
- Use the mounting bracket approved by the Company. Otherwise, the accidental drop of the HM652 may injure people in the vehicle.
- Install the HM652 at a position where you can easily reach the front panel.
- To facilitate wiring, keep sufficient space at the back of the HM652.
- When replacing the fuse for the DC power cord, ensure the new fuse shares the same specification with the old one.
- If any other communication devices such as repeaters are near the HM652, keep the antenna of these devices at least 10 meters away from that of the HM652.

3.2 Tools

- electric drill
- Phillips screwdriver
- T20 torx screwdriver

3.3 Parts

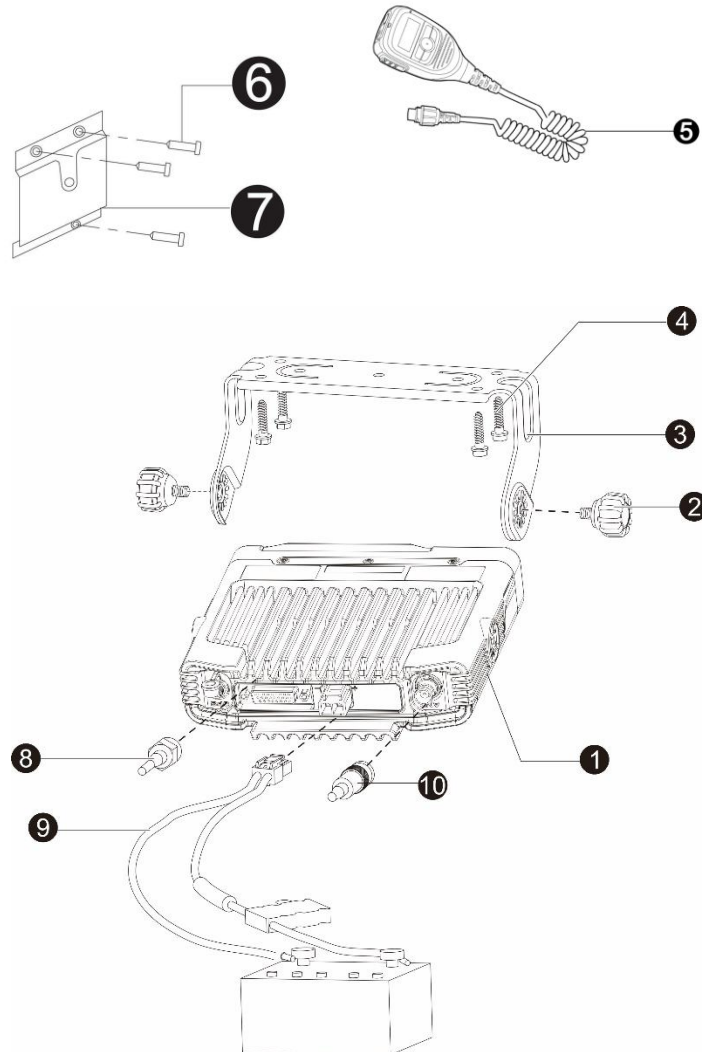

No.	Part Name	No.	Part Name
1	HM652	6	Self-tapping Screw (4 mm x 16 mm)
2	Locking Knobs	7	Microphone Hanger
3	Mounting Bracket	8	GNSS Antenna
4	Self-tapping Screw (4.8 mm x 20 mm)	9	Power Cord (with fuse)
5	Palm Microphone	10	RF Antenna

 **NOTE**

- The RF antenna is optional.
- The GNSS antenna is available only for the HM652 with the Location feature.

3.4 Procedure

1. Install the HM652.
 - a. Select a location on the vehicle.
 - b. Hold the mounting bracket to the location, and then mark the mounting holes.
 - c. Drill holes at the marks.
 - d. Use the screws (4.8 mm x 20 mm) to secure the mounting bracket.
 - e. Connect the RF antenna, GNSS antenna, and power cord to the HM652.
 - f. Slide the HM652 into the mounting bracket, and then fasten the locking knobs.

2. Install the Palm Microphone.
 - a. Select a location on the vehicle where you can reach the Palm Microphone easily.
 - b. Hold the microphone hanger to the location, and then mark the mounting holes.
 - c. Drill holes at the marks.
 - d. Use the screws (4 mm x 16 mm) to secure the microphone hanger.
 - e. Align the triangle index on the Palm Microphone with the installation index on the HM652.
 - f. Plug the aviation connector on the Palm Microphone into the aviation port on the HM652, and then rotate the connector clockwise to secure it.
 - g. Place the Palm Microphone on the hanger.

4. Basic Operations

4.1 Turn On or Off the HM652



On the HM652 or the Palm Microphone, long press the **On-Off** key.

NOTE

Upon connection to the power supply, the HM652 automatically turns on.

4.2 Adjust the Volume

You can adjust the volume through the Palm Microphone.

- On the home screen, press the < key to decrease the volume or the > key to increase the volume.
- Press the  key to locate the cursor to  , and then press the < or > key.

4.3 Switch Between Day and Night Modes

You can set the LCD display on the Palm Microphone to day or night mode.

1. On home screen, press the  key to locate the cursor to **Day Mode** or **Night Mode**.
2. Press the < key or the > key to switch.



4.4 Set the Backlight to Always On

To facilitate operations on the Palm Microphone in low light conditions, you can set the backlight to be always on.

1. On home screen, press the < key and > key simultaneously.
2. Press the  to locate the cursor to **Lock Backlight** or **Unlock Backlight**.
3. Press the > key to select **Lock Backlight**.
4. Press the < key to confirm.

4.5 Lock or Unlock the Key

To avoid misoperations, you can lock the  key on the Palm Microphone.

1. On home screen, press the < key and > key simultaneously.
2. Press the > key to select **Lock** or **Unlock**.
3. Press < key to confirm.

4.6 Select the Zone

You can select a zone through the Palm Microphone.

- On the home screen, press  key to locate the cursor to the zone No., and then press the < or > key.
- Press the preprogrammed **Zone Up** or **Zone Down** key.

4.7 Select the Channel





















You can select a channel through the Palm Microphone. By default, you can switch to a channel only in the current zone. Only with Cross-Zone Switch enabled, you can switch to a channel in another zone.

- On the home screen, press  key to locate the cursor to the channel No., and then press the < or > key.
- Press the preprogrammed **Channel Up** or **Channel Down** key.
- To direct to the preset channel, press the preprogrammed **Preset Channel** key.

5. Status Indications

5.1 LCD Icons

You can learn about the operating status through the LCD display on the Palm Microphone.

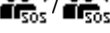
Icon	Description
	The HM652 detects no signal.
	More bars indicate stronger signal.
	The HM652 operates in low power mode.
	The HM652 operates in high power mode.
	An accessory is connected.
	The Location feature is enabled, and valid positioning data has been received.
	The Location feature is enabled, but no valid positioning data has been received.
	The HM652 is scanning.
	The HM652 stays on an active non-priority channel.
	The HM652 stays on active Priority Channel 1.
	The HM652 stays on active Priority Channel 2.
	The HM652 stays on a site.
	The HM652 is roaming.
	The HM652 is in emergency mode.
	The Scrambler or Encryption feature is enabled.
	The HM652 is on a private call.
	The HM652 is making or receiving a private call.
	The HM652 is on a group call.
	The HM652 is making or receiving a group call.
	The HM652 is on an emergency group call.
	The HM652 is making or receiving an emergency group call.

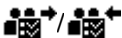
Icon	Description
	The HM652 is on an all call.
	The HM652 is making or receiving an all call.

5.2 LED Indicator

You can learn about the operating status through the LED indicators on the HM652 and the Palm Microphone.

LED Indicator	Radio Status	
Flashes green	The HM652 is being turned on.	
Glow green	The HM652 is receiving.	
Glow red	The HM652 is transmitting.	
Flashes orange slowly	The HM652 is scanning or roaming.	
Flashes orange rapidly	The HM652 is in emergency mode.	
Glow orange	Call hang time: No voice is being transmitted or received during a call. Within such a period, you can press and hold the PTT key and speak.	
Flashes blue	Every 3s	The BT feature is enabled, but no BT device is connected.
	Every 1.5s	A BT device is connected.
	Every 0.1s	The BT feature is being disabled.

NOTE

BT status is indicated only through the LED indicator on the HM652.

6. Call Services

To ensure optimal voice quality on the receiving radio, keep the microphone 2.5 cm to 5 cm away from your mouth during speaking.

6.1 Calls on Digital Channel

On the digital channel, you can make the following calls to the preset contacts.

Call Type	Description
Group Call	A call from an individual user in a group to all the other members in the group.
Private Call	A call from an individual user to another individual user.
All Call	A call from an individual user to all the other users on the current digital channel.

6.1.1 Make a Call

- To make a call to the preset contact on a channel, do as follows:
 - a. Select a digital channel according to [4.7 Select the Channel](#).
 - b. Press and hold the **PTT** key.
- To make a call to the preprogrammed contact, do as follows:
 - a. Press the preprogrammed **One Touch Call** key.
 - b. Press and hold the **PTT** key.

6.1.2 Answer a Call

You can answer a call without any operation.

6.1.3 End a Call

Automatic

The private call or group call ends when the call hang time expires.

Manual

The all call ends when the caller releases the **PTT** key.

6.2 Calls on Analog Channels

6.2.1 Make a Call Without Signaling

On an analog channel without signaling, you can make a call to all the other users on the channel.

1. Select an analog channel according to [4.7 Select the Channel](#).
2. Press and hold the **PTT** key.

6.2.2 Make a Call with Signaling

On an analog channel with signaling, you can initiate a call to a specific contact on the channel.

NOTE

- To configure the signaling, contact your dealer.
- HDC1200 (compatible with MDC1200) and two-tone signaling are available.
- The method to make a call with signaling is the same, regardless of signaling types.

-
1. Select an analog channel according to [4.7 Select the Channel](#).
 2. Press and hold the **PTT** key or the preprogrammed **One Touch Call** key.

7. Basic Settings

7.1 Power Level

To adjust the power level to high or low, press the preprogrammed **Power Level Adjust** key.

7.2 Audio

7.2.1 Microphone and Speaker



The HM652 features no microphone or speaker, so you need to connect an audio accessory to the HM65X.

You can switch the audio modes of the microphone and speaker only when you connect the following accessories to the HM652 simultaneously:

- Palm Microphone (connected to the aviation port)
- Optional audio accessory (connected to the accessory connector)

Microphone

Option	Description	Operation
Follow PTT	<ul style="list-style-type: none"> ● When you transmit voice through the PTT key on the Palm Microphone, the HM652 uses the microphone on the Palm Microphone. ● When you transmit voice through the optional audio accessory, the HM652 uses the microphone on the optional audio accessory. 	Press the preprogrammed Mic Set Switch key.
Only Internal	The HM652 uses only the microphone on the Palm Microphone.	
Only External	The HM652 uses only the microphone on the optional audio accessory.	

Speaker

Option	Description	Operation
Only Internal	The HM652 uses only the speaker on the Palm Microphone.	Press the preprogrammed SPK Set Switch key.
Only External	The HM652 uses only the speaker on the optional audio accessory.	
External First	When the optional audio accessory is connected, the HM652 uses the speaker on the optional audio accessory. Otherwise, the HM652 uses the speaker on the Palm Microphone.	

7.2.2 Mic AGC

Mic AGC allows the transmitting HM652 to control the voice output gain within a proper range during transmission, so as to provide improved voice with proper volume for the receiving party. This feature ensures stable voice even in noisy environment.

NOTE

To enable Mic AGC, contact your dealer.

7.2.3 AI-based Noise Cancellation

AI-based Noise Cancellation allows the HM652 to automatically cancel out ambient noise when receiving or transmitting voice. This feature enhances the voice clarity.

To enable or disable AI-based Noise Cancellation, press the preprogrammed **AI-based Noise Cancellation** key.

NOTE

To configure AI-based Noise Cancellation, contact your dealer.

7.3 USB Path

You can select a USB path for communication between the HM652 and peripheral devices. For details, see the following table:

Option	Description	Operation
Rear Port First	When both aviation port and accessory connector are connected to peripheral devices, the accessory connector is used as the USB path.	To switch the USB path, press the preprogrammed USB Path Switch key.
Only Front Port	Only the aviation port can be used as the USB path.	
Only Rear Port	Only the accessory connector can be used as the USB path.	

7.4 Location

Location allows you to collect the position information of the HM652 through satellites.

NOTE

- The Location feature is available only for the HM652 with GPS, BDS, or GLONASS.
- To enable Location, contact your dealer.

7.4.1 Voice with Location

Voice with Location allows the HM652 to report its position information when making a private call, a group call, or an emergency call.

To send voice with location, press the **PTT** key.



NOTE

- To enable Voice with Location, contact your dealer.
 - You can ask your dealer to set the HM652 to send the position information only once or periodically in a preset interval.
-

7.4.2 GPS Report

GPS Report allows the HM652 to report its position information to the control center.

Manual

Press the preprogrammed **GPS Report** key

Automatic

To make the HM652 automatically report location, contact your dealer. The trigger conditions can be set to power-on, power-off, interval time, or distance.

7.4.3 Quick GPS

Based on GPS standard time, Quick GPS divides the GPS upload time into several equal-length time slices. These time slices are assigned to the HM652 with different configurations for periodic upload and single upload. Each HM652 uses the same GPS upload time length to upload GPS data, improving upload efficiency and reliability.

If your dealer configures Quick GPS to a digital channel, the channel will report the quick GPS data only.

7.5 BT



CAUTION

- It is recommended that you use the BT device approved by the Company.
 - If the BT earpiece of other makes is used, use it with the BT Ring PTT produced by the Company. Otherwise, the earpiece cannot transmit the voice.
 - To enable BT, contact your dealer.
-

BT is a wireless technology that supports short-distance communications and data exchange between devices.

You can connect the HM652 to a BT device through the built-in BT module.

7.5.1 Enable BT

Press the preprogrammed **BT** key.

If your dealer enable both BT and BT Visibility, the HM652 automatically enables BT and is always discoverable by other BT devices upon power-on.

7.5.2 Connect to a BT Device

Only after the connection between the HM652 and the BT device is established, the HM652 can automatically search and connect to the BT device.



To establish the connection between the HM652 and the BT device, contact your dealer.

7.5.3 Switch the Audio Output Path

To switch the audio path between the BT earpiece and the Palm Microphone, press the preprogrammed **BT Audio Switch** key.

8. Safety and Security

8.1 Horn & Lights

To remind you to respond an emergency alarm, call alert, or private call in time, Horn & Lights triggers the HM652 to alarm through the external alarm devices (speaker or light) if you have no operations within the preset duration.

Alarm Type	Description
Alarm Re-Arm	Horn & Lights is enabled or disabled based on the setting upon the latest power-off.
Non-Permanent Manual Re-Arm	Horn & Lights must be enabled every time upon power-on.
Permanent External Alarm	Horn & Lights is enabled whenever the HM652 is turned on.

To enable or disable Horn & Lights, press the preprogrammed **Horn & Lights** key.

8.2 Emergency

The Emergency feature allows you to seek help from your companion or the control center in emergencies. You can make an emergency call with the highest priority even when your HM652 is transmitting or receiving.

In emergency mode, the HM652 transmits at high power level by default. According to the emergency type preset by your dealer, the HM652 gives different indications. The available emergency types are listed in the following table:

Emergency Type	Description
Siren Only	The HM652 emits siren, but does not transmit any emergency signal to the control center.
Regular	The HM652 gives visible or audible indications.
Silent	The HM652 gives no visible and audible indication.
Silent w/Voice	The HM652 gives audible indications only upon receiving a call. Otherwise, the HM652 gives no audible or visible indication.
Alarm w/Siren	The HM652 transmits the emergency signal to the control center, and then emits siren.

In addition, you can request your dealer to set any of the following emergency modes:

Emergency Mode	Description	Note
Call Only	Allows you to make an emergency call.	

Emergency Mode	Description	Note
Alarm w/Call	Allows you to send an emergency code and initiate an emergency call.	If the emergency type is Siren Only or Alarm w/Siren, you do not need to set the emergency mode.
Alarm	Allows you to send an emergency code.	

8.2.1 Make an Emergency Call

To make an emergency call to the preset emergency contact, press the preprogrammed **Emergency On** key.

If Alarm w/Call To Follow is enabled by your dealer, you can speak into the microphone without pressing or holding the **PTT** key. If the preset voice cycles expire, you can press and hold the **PTT** key to make an emergency call again.

8.2.2 Answer an Emergency Call

You can answer an emergency call without any operation.

8.2.3 End an Emergency Call

- For Caller
 - Press the preprogrammed **Emergency Off** key.
 - Turn off the HM652.
- For Callee
 - Switch the channel.
 - Turn off the HM652.

8.3 Lone Worker

Lone Worker allows the HM652 to automatically send an emergency alarm to your companion or the control center in either of the following scenarios:

- You do not operate the HM652 within the preset time.
- The HM652 does not transmit voice within the preset time.

To exit the emergency mode, do any of the following:

- Press the keys.
- Rotate the knob.
- Transmit voice.

To enable or disable Lone Worker, press the preprogrammed **Lone Worker** key.

 **NOTE**

To configure Lone Worker, contact your dealer.

8.4 Encryption

Encryption refers to end-to-end encryption (E2EE), which protects voice and data against eavesdropping.

To enable or disable Encryption, press the preprogrammed **Scrambler/Encrypt** key.

 **NOTE**

- To configure Encryption, contact your dealer.
 - Encryption is valid for the current channel. When switching to the current channel, the HM652 automatically enables Encryption.
-

8.5 Emergency Erase Data

Emergency Erase Data allows the HM652 to erase encrypted data in emergencies, so as to prevent unauthorized access.

When erasing the data, the HM652 stops voice and data services and the Palm Microphone returns to the home screen.

The data can be erased in the following scenarios:

- Press the **P1** key and then the **PTT** key (within 1.5s) for two times, and then press the **P1** key again.
 - ~~When the HM652 is disabled, the data in the HM652 will be erased automatically.~~
-

 **NOTE**

To configure Emergency Erase Data, contact your dealer.

8.6 Radio Disable and Radio Enable

- Radio Disable allows you to disable the HM652 by sending a Radio Disable command to the HM652.

The disabled HM652 can be monitored remotely, but is deprived of other features.

- Radio Enable allows you to enable the disabled HM652 again by either of the following:
 - Send a Radio Enable command to the HM652.
 - Program the HM652 again.

9. Advanced PMR Features

NOTE

To configure features in this chapter, contact your dealer.

9.1 One Touch Call

One Touch Call allows you to initiate a preset service by pressing the preprogrammed **One Touch Call** key.

You can choose any of the following preset services:

Channel Type	Services	Operation
Analog channel	Make a call to a 2-tone contact.	Press the preprogrammed One Touch Call key.
Digital channel	<ul style="list-style-type: none"> ● Make a group call, private call, or all call. ● Send a quick text message or position message to a private or group contact. ● Initiate an Alert Call, Radio Check, Remote Monitor, Radio Disable, or Radio Disable service to a private contact. 	

 **NOTE**

To make a call on a digital channel, you must press and hold the **PTT** key after pressing the **One Touch Call** key.

9.2 Scan

Scan allows you to listen to activities on other channels, keeping track of your team members.

To enable or disable Scan, press the preprogrammed **Scan** key.

NOTE

If you do not want to hear activities on the channel, press the preprogrammed **Nuisance Temporary Delete** key to remove the channel from the scan list temporarily.

9.3 Roam

Roam allows the HM652 to select base stations according to signal strength. This ensures seamless communication across sites or networks.

To enable or disable Roam, press the preprogrammed **Roam** key.

9.4 Talk Around

Talk Around allows you to continue communication in direct mode when the repeater malfunctions or the HM652 is

out of the repeater's coverage.

To enable or disable Talk Around, press the preprogrammed **Talk Around** key.

9.5 Squelch Level

Squelch Level refers to the squelch threshold required for the speaker of the Palm Microphone. The higher squelch level requires a stronger signal.

To adjust the level, press the preprogrammed **Adjust Squelch Level** key.

9.6 Clarity Transmission

Clarity Transmission allows data transferred from one external device to another using the HM652. The HM652 serves as the transparent transmission channel for data exchange between external devices without any additional adjustment.

9.7 Priority Interrupt

Priority Interrupt allows you to interrupt the ongoing activities (such as a call, a call hang status or remote monitor) on the current channel to release this channel, so that you can initiate a new call or a new data service on this channel.

Manual

Press the preprogrammed **Priority Interrupt** key.

Automatic

Auto Priority Interrupt includes the following:

- Emergency Priority Interrupt
- Call Back Priority Interrupt
- Message Priority Interrupt
- Radio Disable Priority Interrupt
- All Call Priority Interrupt

With Auto Priority Interrupt configured by your dealer, you can interrupt an ongoing call by initiating an emergency call, all call, or sending a short message or the Radio Disable command.

9.8 Ignition Sense

Ignition Sense controls the HM652 on or off and the **PTT** key enabled or disabled by starting or stopping your vehicle.

Four types of ignition sense are listed in the following table. The default type is **Disable Ignition Off**, and other types

are configured by your dealer.

Type	Description	Operation
Ignition or Switch	Allows you to turn on or off the HM652 by the engine or the On-Off key.	<ul style="list-style-type: none"> ● To turn on the HM652, start the engine or long press the On-Off key. ● To turn off the HM652, stop the engine or press the On-Off key.
Ignition Only	Allows you to turn on or off the HM652 only by the engine.	To turn on or off the HM652, start or stop the engine.
PTT Disable	Allows you to enable or disable the PTT key by the engine.	To enable or disable the PTT key, start or stop the engine.
Disable Ignition Off	Allows you to turn on the HM652 by the engine or the On-Off key, and turn off the HM652 only by the On-Off key.	<ul style="list-style-type: none"> ● To turn on the HM652, start the engine or long press the On-Off key. ● To turn off the HM652, press the On-Off key.

9.9 Public Address

Public Address allows you to address public through the external speaker (connected to the accessory connector).

To enable or disable Public Address, press the preprogrammed **Public Address** key.

9.10 XPT

In the Extended Pseudo Trunk (XPT) system, the HM652 can communicate with each other on the logic channels of all repeaters, no longer limited to a dedicated control channel. This improves the channel usage and ensures stable communication.

10. Troubleshooting

Phenomena	Analysis	Solution
The HM652 fails to be turned on.	The power cord may be disconnected.	Connect the power cord properly.
The voice is unclear.	The signal may be weak.	Make sure that call participants are within the communication range.
During receiving, the voice is weak, discontinuous, or totally inactive.	The volume may be low.	<ul style="list-style-type: none"> ● Increase the volume. ● Contact your dealer to disable Mic AGC.
	The antenna may be loosened or installed improperly.	<ol style="list-style-type: none"> 1. Turn off the HM652. 2. Reattach the antenna.
	The speaker may be blocked or damaged.	Clean the surface of the speaker.
Communications with group members are unavailable.	The frequency or signaling type may be inconsistent with that of other members.	Set your TX/RX frequency and signaling to the same as that of other members.
	The channel type (digital or analog) may be set inconsistently.	Make sure that all members are on the same digital or analog channel.
	You may be too far away from the group members.	Move towards other members.
	The signal may be weak.	Make sure that call participants are within the communication range.
There are unknown voices or noises on the channel.	You may be interrupted by radios using the same frequency.	<ul style="list-style-type: none"> ● Change the frequency. ● Adjust the squelch level.
	The HM652 may be set with no signaling.	Set signaling for all member radios to avoid interference at the same frequency.
There is too much noise and hiss.	The signal may be weak.	Make sure that call participants are within the communication range.

Phenomena	Analysis	Solution
	The HM652 may be in an unfavorable position. For example, the signal may be blocked by high-rise buildings or frustrated in the underground areas.	<ol style="list-style-type: none"> 1. Move to an open and flat area. 2. Restart the HM652.
	The HM652 may suffer from external disturbance (such as electromagnetic interference).	Stay away from the equipment that may cause interference.
The keys are unavailable.	The keypad may not work temporarily.	Restart the HM652.
The GPS cannot locate your position.	The GPS module is not properly connected.	Reconnect the GPS module.
	The HM652 may be at an unfavorable position, so no GPS signal is received.	Move to an open and flat area, and try again.

If the above solutions cannot solve your problems, or you may have some other queries, please contact us or your local dealer for more technical support.

11. Care and Cleaning

To guarantee optimum performance as well as a long service life of the product, please follow the tips below.

11.1 Product Care

- Do not pierce or scrape the product.
- Keep the product away from substances that can corrode the circuitry.
- Close the accessory connector cover when no accessory is in use

11.2 Product Cleaning

CAUTION

Turn off the product and remove the battery before cleaning.

- Clean up the dust and fine particles on the product surface and charging piece with a clean and dry lint-free cloth or a brush regularly.
- Use neutral cleanser and non-woven fabric to clean the keys, knobs, and front case after long-time use. Do not use chemical preparations such as stain removers, alcohol, sprays or oil preparations, so as to avoid surface case damage.
- Make sure the product is completely dry before use.

12. Optional Accessories

CAUTION

Use the accessories approved by the Company only. Otherwise, we will not be liable for any loss or damage arising out of the use of unauthorized accessories.

Contact your local dealer for the optional accessories used with the HM652.

13. Abbreviations

Abbreviation	Full Name
E2EE	End-to-End Encryption
GPS	Global Positioning System
GNSS	Global Navigation Satellite System
LCD	Liquid-Crystal Display
LED	Light-Emitting Diode
PTT	Push-To-Talk
RRS	Radio Registration Services
TK	Top Key
XPT	Extended Pseudo Trunk



© 2023 Hytera US Inc. All Rights Reserved.

8 Whatney, Irvine, CA 92840

support@hytera.us

<https://www.hytera.us>